

Victor

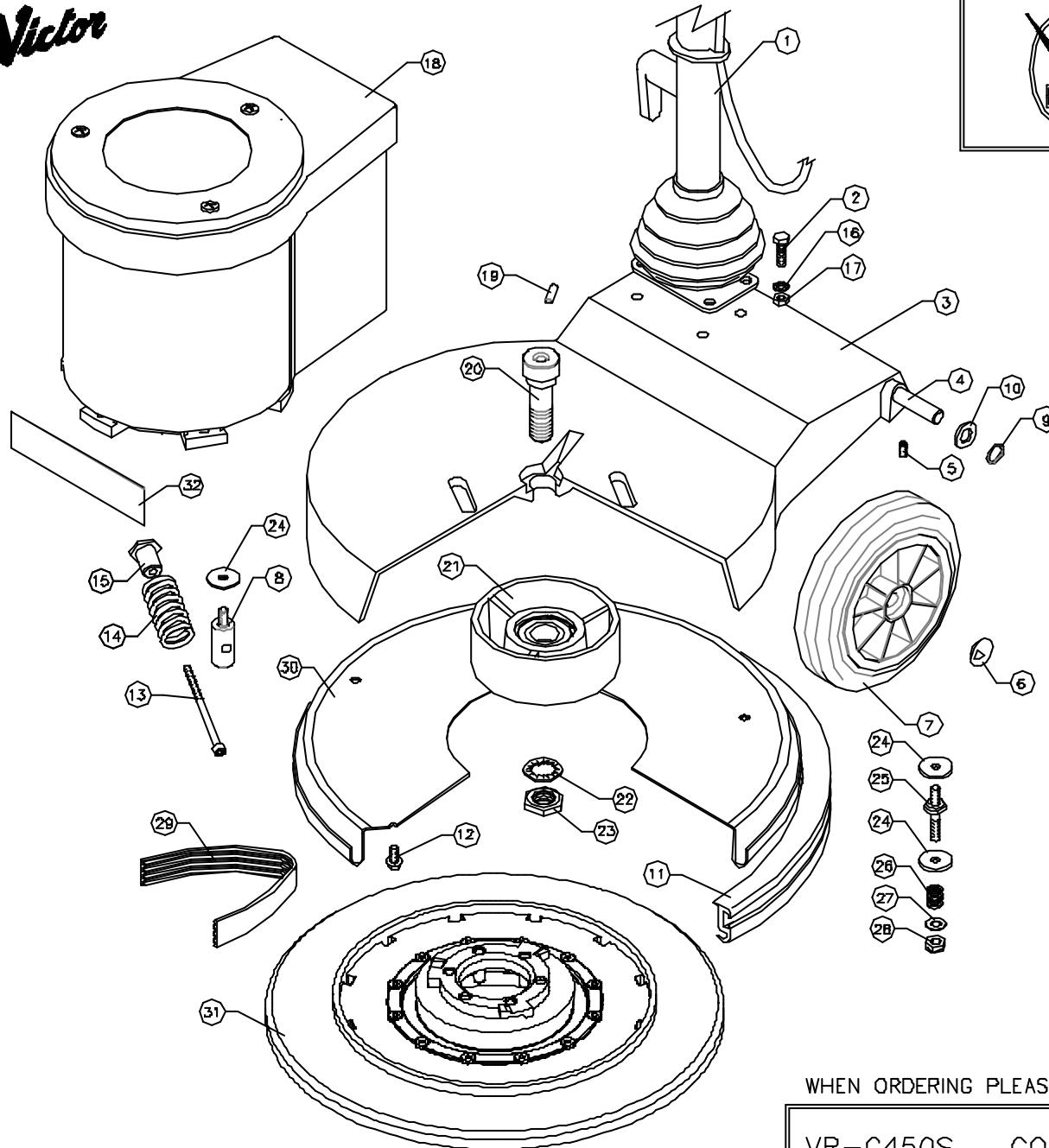

DOWDING & PLUMMER Ltd.

CALTHORPE HOUSE, STOCKFIELD ROAD,
BIRMINGHAM B27 6AP - ENGLAND
TEL: 0121-706-5771 FAX: 0121-708-1052



ITEM	PART No.	QTY.	DESCRIPTION
1	AYH1800/C	1	HANDLE ASSEMBLY
2	MBX30BH	4	M8 x 30HEX HEAD SCREW
3	A136B/B/GH	1	450 BASE GREY HAMMER
4	A187B/PLTD	1	WHEEL AXLE PLATED
5	M6X8SC	1	M6 x 8 SOCKET GRUB SCREW
6	SBI3005/A	2	12mm STARLOCK CAP
7	SBI6100/NT	2	7" WHEEL - BLACK
8	A1766	1	MOTOR PILLAR STUD
9	SBI3666	2	WAVEY WASHER - PLW4
10	M12W	2	12mm PLAIN WASHER
11	A1753/B/BL	1	54° Q/R BUFFER RING - BLACK
12	M6X12TT	5	M6 x 12 TAPTITE SCREW
13	A1864	1	BELT TENSIONING SCREW - M6x90
14	A1850	1	SPRING
15	A1865	1	SPRING RETAINER
16	M8WSP	4	M8 SPRING WASHER
17	M8N	4	M8 NUT
18	AYM2188	1	MOTOR ASSEMBLY
19	SBI5550	1	1/4" x 5/8" SELOCK PIN
20	A1674	1	CENTRE FEED PULLEY BOLT
21	AYP1016	1	Ø157mm OUTPUT PULLEY ASSEMBLY
22	M20WSH	1	M20 SHAKEPROOF WASHER
23	M20N	1	M20 FULL NUT
24	A1378	7	WASHER (30x9x2.5mm)
25	A1843	3	MOTOR STUD
26	A2132	3	MOTOR STUD SPRING
27	M8W	3	M8 PLAIN WASHER
28	M8NSB	3	M8 BINX STIFF NUT
29	SBI3823	1	220J16 POLYVEE DRIVE BELT
30	B1054/GH	1	BRUSH COVER PRESSING - 450mm
31	VB45141	1	DRIVE BOARD ASSEMBLY
32	D0803	1	CONTRACTOR LABEL

WHEN ORDERING PLEASE QUOTE PART No. AND PART DESCRIPTION